

Models LC, L2 & L3 Installation, Operation, and Maintenance Manual

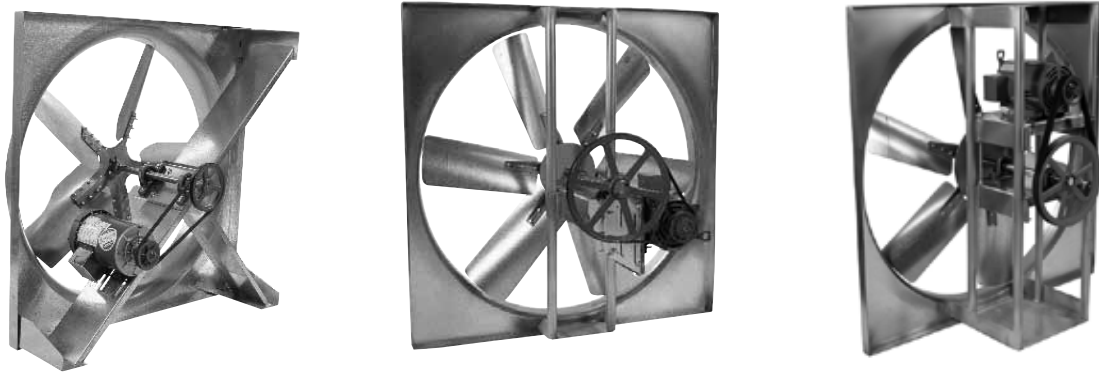

Belt Drive Sidewall Propeller Fans Exhaust and Supply

READ AND SAVE THESE INSTRUCTIONS

The purpose of this manual is to aid in the proper installation and operation of fans manufactured by JencoFan. These instructions are intended to supplement good general practices and are not intended to cover detailed instruction procedures, because of the wide variety and types of fans manufactured by JencoFan.

INSTALLATION, OPERATION AND MAINTENANCE MANUAL

INTRODUCTION:

DO NOT INSTALL, USE OR OPERATE THIS EQUIPMENT UNTIL THIS MANUAL HAS BEEN READ AND UNDERSTOOD. READ AND SAVE THESE INSTRUCTIONS FOR FUTURE USE.

It is the responsibility of the purchaser to assure that the installation and maintenance of this equipment is handled by qualified personnel experienced in such work and equipment.

Contact your local representative should you need further information.

SHIPMENT AND RECEIVING:

Prior to shipment, all fans have been thoroughly inspected and tested.

All equipment shipped from JencoFan is skidded or crated to fully comply with trucking requirements. Inspect all shipments carefully for damage. **THE RECEIVER MUST NOTE ANY DAMAGE ON THE CARRIER'S BILL OF LADING AND FILE A CLAIM IMMEDIATELY WITH THE FREIGHT COMPANY, IN THE CASE OF ANY DAMAGE.** Keep a record of all equipment received, including inspection details and date of receipt, because of the possibility of partial shipments.

If you receive damaged goods, contact your JencoFan representative for repair or replacement service.

HANDLING:

Handle your equipment with caution. Some fans are provided with lifting lugs or holes for easy handling. Others must be handled using nylon straps that protect the fan's coating and housing. Spreader bars should be used when lifting large parts.

Fans should be lifted by using straps around the fan housing only. **DO NOT LIFT FANS BY THE MOTOR, BASE, PROP, WHEEL, OR FLANGES.**

Roof ventilators should be lifted by using straps around the fan housing or base only. Spreader bars should also be used to avoid damage to stack caps or hoods. **DO NOT LIFT ROOF VENTILATORS BY THE STACK CAP OR HOOD.** On hooded units, disassemble the stack from hood when lifting. Upblast models may be lifted assembled.

STORAGE:

If fans are stored for any length of time, they should be stored in a clean, dry location to prevent rust and corrosion. Outdoor storage is not recommended. When outdoor storage is necessary, they should be protected from the elements as best as possible. Cover the fan inlet and outlet and keep motors dry and clean.

For extended storage (more than 3 months), motor shafts and bearings should be rotated monthly. If stored greater than 6 months, bearing grease in motor and fan should be purged and replaced with compatible grease. Re-check belts for proper tension. Storage records should be kept to assure proper maintenance. The factory can advise warranty centers to provide motor and bearing service if needed.

INSTALLATION:

Roof ventilators should always be mounted to a flat level, solid and rigid structure. Particular caution should be exercised when installing fans on metal buildings. Be sure wall or roofs are capable of supporting the fan(s). Walls/ Roofs not supported correctly will cause vibration that could cause damage or injury.

Fans mounted off ground level should be rigidly mounted to a special platform and be placed as near as possible to, or over, a solid wall or column.

Supports for suspended fans must be crossbraced for live load support to prevent side sway.

Use guy wires to help secure roof units if excessively windy conditions prevail.

1. **CAUTION!** This fan contains rotating parts and requires special service. Appropriate safety precautions should be taken during installation, operation and maintenance.
2. **WARNING!** Do not install or operate this fan in an environment or atmosphere where combustible or flammable materials, gasses or fumes are present, unless it was specifically designed and manufactured for use in that environment. Explosion or fire can result. Explosive, corrosive, high temperature, etc. conditions may require special construction, inspection and maintenance. It is necessary to observe the fan manufacturer's recommendations and limitation concerning the type of material to be handled by the fan and its application in special conditions.
3. When ventilator is designed to be mounted on a curb, the curb should be securely installed prior to fan installation.
4. A damper, if used, should be securely mounted within the curb or wall in a manner that allows free and unobstructed operation.
5. **CAUTION!** All electrical work must be done in accordance with local and/or national electrical codes as applicable. If you are unfamiliar with methods of installing electrical wiring, secure the services of a qualified electrician.
6. **WARNING!** This product must be grounded.
7. **DANGER!** Make sure power is turned off and locked in the **OFF** position at the service entrance before installing, wiring or servicing fan.
8. **CAUTION!** Before wiring the motor, check the supply voltage against the motor nameplate voltage. High or low voltage can damage the motor and void the motor warranty.
9. **WARNING!** Be sure to keep all wiring clear of rotating or moving parts.
10. **WARNING!** Before starting the fan, turn the wheel to assure it rotates freely. If needed, adjust the wheel/shaft/bearing/motor position as required to achieve necessary clearances.
11. **CAUTION!** On belt drive units, assure belts are tensioned and aligned properly. (See Maintenance section).
12. **WARNING!** Check all setscrews and keys. Tighten as necessary prior to fan startup.
13. On roof units, anchor the fan securely to the curb. Anchoring through the vertical portion of the curb cap flange is recommended. Use a minimum of four lag bolts or other suitable fasteners.
14. Due to the general nature of its applications, the basic air mover is available with protective guards and/or other devices for required operating safety as with most installations of rotating machinery. Before operating the basic unit in any of its applications determine requirements for such guards and/or devices needed for protection against accidental contact with moving parts or against injury to nearby personnel or critical equipment due to accidental rupture of fast moving parts.

START-UP:

Lock out the power source.

Tighten all bolts and setscrews securely and, on belt drive fans, check sheave alignment and belt tension. Tighten belts if necessary. **NOTE THAT ALL BOLTS, SETSCREWS AND BELTS SHOULD BE TIGHTENED AFTER TWO DAYS OF INITIAL OPERATION.**

Clearance should be checked all around between wheel or propeller tips and the housing before starting up. The wheel or propeller should not strike the housing.

No initial lubrication is required. Motors have been pre-lubricated by motor manufacturer and fan bearings by JencoFan.

Arrows to show direction of rotation and airflow are attached to the fan housings.

After the electrical connections are completed, apply just enough power to start the impeller as indicated by the directional arrows on the unit. If the impeller is turning the wrong direction, it will not deliver rated airflow and the motor connections must be altered to correct rotation.

Lock out the power source before the installation of all accessories.

Fan electrical power can now be applied and special attention should be given to determine if motor is working properly. At this time, with air system in full operation, with guards attached, it is well for the electrician to measure the operating amperage of the motor and compare with the nameplate rating to determine that the motor is operating under safe load conditions.

The fan should not need balancing, as it was balanced at the factory to meet stringent vibration levels before shipment. However, there are several things that may cause vibration, such as rough handling in shipment and erection, weak foundations, and alignments.

MAINTENANCE:

1. Before performing any maintenance on the fan, be sure power is turned off and locked in the OFF position at the service entrance before servicing the fan.
2. Ventilators should be carefully checked at least once a year. For critical or rugged applications, a routine check every two or three months is suggested.
3. All motors supplied with JencoFan ventilators carry a one-year warranty from date of shipment. For repairs within the warranty period, the motor must be taken to the motor manufacturer's authorized service dealer. Contact your representative for additional warranty details.
4. A periodic motor check should consist of spinning the motor shaft with the power off to be sure the motor turns freely and the bearings run smoothly. The belt on belt driven units should be removed from the motor sheave.
5. When removing or installing a belt, do not force the belt over the sheave. Loosen the motor mount so that the belt can be easily slipped over the sheave.
6. The belt on belt driven units should be removed and carefully checked for radial cracks, ply separation or irregular wear. A small irregularity in the contact surface of the belt will result in noisy operation. If any of these defects are apparent, the belt should be replaced. Check the sheaves also for chipping, dents or rough surfaces, which could damage the belt.
7. The correct belt tension is important. If the belt is too tight it will result in excess bearing pressure on the motor bearings and shaft pillow block and may also overload the motor. If the belt is too loose it will result in slippage, which will quickly burn out belts. A belt should feel "live" when thumped, approximately 1/4" belt deflection when subject to finger pressure (3-5 lb.) at midpoint between sheaves.
8. The belt alignment should also be checked to be sure the belt is running perpendicular to the rotating shafts. Motor and drive shafts must be parallel. Improper alignments will result in excessive belt wear.
9. Check sheave set screws to ensure tightness. Proper keys must be in keyways.
10. Do not readjust blade pitch or fan RPM. If sheaves are replaced, use only sheaves of identical size and type.
11. If unit is to be left idle for an extended period, it is recommended that belts be removed and stored in a cool, dry place to avoid premature belt failure.
12. The standard pillow block bearings on belt driven ventilators are factory lubricated and are provided with external grease fittings. Relubrication annually or more frequently, if required, is recommended.

13. During the first few months of operation, it is recommended that the setscrews be checked to assure they are tight.
14. The rotating wheel or propeller requires particular attention in most applications since materials in the air being handled can build up on the blades to cause destructive vibration; and may also corrode and/or erode the blade metal to weaken the structure of the propeller. Regular inspection and corrective action at intervals determined by the severity of each application are essential to good service life.

BEARINGS AND LUBRICATION:

All JencoFan belt drive fan bearings are heavy duty, self-aligning ball type and are relubricable for continuous service.

Selection of the correct bearing grease and greasing intervals depends on several things. Extreme high or low temperatures, dirty or damp surrounds, and vibration exceeding 1 or 2 mils are all things that will require more frequent greasing or special greases. For standard service, use a lithium base grease that conforms to NLGI grade 2 consistency.

The motor bearings and the fan bearings on the belt drive fans should be greased at regular intervals. Motor manufacturer's greasing instructions and recommendations should be followed closely. Avoid the use of a pressure greasing system which tends to fill the bearing chamber completely. Do not over grease. Use only 1 or 2 shots with a hand gun in most cases. Maximum hand gun rating 40 P.S.I. Rotate bearings during lubrication where good safety practice permits. NOTE: On motors with non-regreasable sealed bearings, no lubrication is required for the life of the bearings.

Some of the most frequent causes of bearing failure is not greasing often enough, using an excessive quantity of grease, or using incompatible greases. Excessive vibration, especially if the bearing is not rotating, will also cause bearings to fail. Bearings must also be protected from water and moisture to avoid internal corrosion.

BEARING REPLACEMENT:

Fan bearings on belt drive fans should not need to be replaced for many years if the above recommendations are strictly adhered to. However, use the following procedure when bearing replacement is necessary:

1. Gain access to the fan bearings. Remove the bearing cover, if any.
2. Loosen the belts by shifting the motor.
3. Remove the propeller and disconnect the remote lube tubes (if applicable).
4. Measure the location of the bearing to the propeller end of the shaft and the bearing spacing.
5. Remove the shaft and bearing assembly. Note the position of the bearings' shims (if applicable).
6. Loosen all bearing/shaft setscrews or other locking device.
7. Remove bearings (may have to be pressed off the shaft).
8. Polish the shaft with fine emery paper (240 Grit or finer) and file the setscrew dimples flat.
9. Install new bearings on the shaft, making sure that the collars are together, (i.e., facing each other on the shaft). Lightly seat one setscrew or eccentric locking collar on each bearing to hold in the approximate marked position.
10. Mount the shaft/bearing assembly in the fan, with bolts. Do not tighten yet. Just snug up. Loosen the setscrew.
11. Center the shaft in the house (both ends) as closely as possible. (The fan propeller may need to be temporarily installed to get its clearances equal).
12. Tighten the bearing mounting bolts.
13. Reinstall the lube tubes (if applicable).

14. Install bearing cover, propeller, and belts, and adjust the motor to get proper belt tension. Also, make sure that the sheaves are properly aligned.

15. If a new shaft is supplied, then ignore items #6 through #8.



V-BELTS:

V-belts on JencoFan belt drive fans are oil, heat and static resistant type, and oversized for continuous duty. With proper installation and maintenance, years of operating efficiency can be added to the life span of the V-belt drive.

The condition of V-belts and the amount of belt tension should be checked prior to start-up. When it becomes necessary to adjust belt tension, do not over-tighten as bearing damage will occur. Recommended belt tension should permit 1/64" per inch of span deflection of the belt on each side of the belt measure half-way between the pulley centerline. Extreme care must be exercised when adjusting V-belt as not to misalign the pulleys. Any misalignment will cause a sharp reduction in belt life and will also produce squeaky, annoying noises. On units equipped with 2 or 3 groove pulleys, adjustments must be made so that there is equal tension on all belts.

1. Where tensioning rods are not provided, adjustment is easily obtained by loosening and adjusting one side of the motor bracket at a time.
2. Always loosen tension adjustment enough to place belts on sheaves without running belts over the edge of either sheave. A new belt may be seriously damaged internally by careless handling.

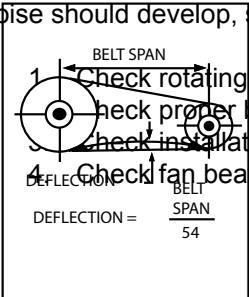
WARNING: Whenever belts are removed or installed, never force belts over pulleys without loosening motor first to relieve belt tension. The fan has been checked at the factory prior to shipment for mechanical noises. If mechanical noise should develop, some suggestions are offered as a guide to remedy the cause:

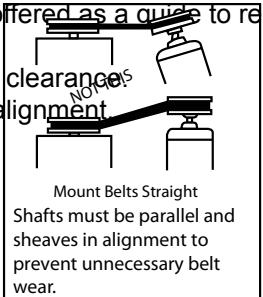
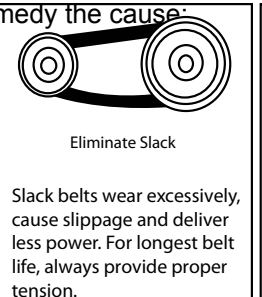
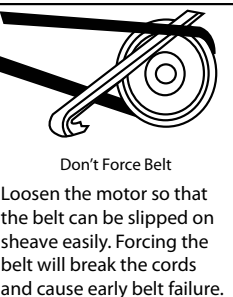
 <p>1. Check rotating member 2. Check proper belt tension 3. Check installation and alignment 4. Check fan bearings</p> $\text{DEFLECTION} = \frac{\text{BELT SPAN}}{54}$	 <p>Adjust Variable Sheaves Properly</p> <p>Provide adequate clearance</p> <p>Proper pulley alignment</p> <p>Two-groove variable pitch sheaves must be opened the same number of turns on both sides, otherwise slippage is induced, wearing belts rapidly.</p>	 <p>Mount Belts Straight</p> <p>Shafts must be parallel and sheaves in alignment to prevent unnecessary belt wear.</p>	 <p>Eliminate Slack</p> <p>Slack belts wear excessively, cause slippage and deliver less power. For longest belt life, always provide proper tension.</p>	 <p>Don't Force Belt</p> <p>Loosen the motor so that the belt can be slipped on sheave easily. Forcing the belt will break the cords and cause early belt failure.</p>
-------------------------------------------------------------------------------------------------------------------------------------------------------------------------------------------------------------------------------------------------------------------------	---------------------------------------------------------------------------------------------------------------------------------------------------------------------------------------------------------------------------------------------------------------------------------------------------------------------------------------------------	----------------------------------------------------------------------------------------------------------------------------------------------------------------------------------------------------------	----------------------------------------------------------------------------------------------------------------------------------------------------------------------------------------------------------------------------------------------	------------------------------------------------------------------------------------------------------------------------------------------------------------------------------------------------------------------------------------------------------------

MOTORS:

The fundamental principle of electrical maintenance is **KEEP THE MOTOR CLEAN AND DRY**. This requires periodic inspection of the motor. The frequency depends upon type of motor and the service.

We recommend periodic checks of voltage, frequency, and current of a motor while in operation. Such checks assure the correctness of frequency and voltage applied to the motor, and yield an indication of the fan load. Comparison of this data with previous data will give an indication of the fan performance. Any serious deviations should be investigated and corrected.

Fractional motors usually have prelubricated sealed bearings with no grease fittings and are lubricated for life.

Lubricate integral horsepower motors per the motor manufacturer's recommendations. Lubrication frequency depends on the motor horsepower, speed, and service. Use compatible greases.

1. All motors carry a one (1) year warranty from date of shipment. For repairs within the warranty period, the motor must be taken to the motor manufacturer's authorized service dealer. Contact your representative for additional warranty details.
2. A periodic motor check should consist of spinning the motor shaft with the power off to be sure the motor turns freely and bearings run smoothly. The belt on belt driven units should be removed from the motor pulley.

RECOMMENDED BALL AND ROLLER BEARING GREASES SUGGESTED REGREASING INTERVALS

INTERVAL	TYPES OF SERVICE
1-2 YEARS	INFREQUENT OPERATION OR LIGHT DUTY IN CLEAN ATMOSPHERE
1 YEAR	8-16 HRS/DAY IN CLEAN, RELATIVELY DRY ATMOSPHERE
6 MONTHS	12-24 HRS/DAY, HEAVY DUTY, OR IF MOISTURE IS PRESENT
3 MONTHS	HEAVY DUTY IN DIRTY, DUSTY LOCATIONS: HIGH AMBIENTS: MOISTURE LADEN ATMOSPHERE: VIBRATION

CAUTION

Greases by different soap bases (lithium, sodium, etc.) may not be compatible when mixed. Prevent such intermixing by completely purging the bearing of old greases.

Note: Use regreasing intervals and grease as noted in tables, unless a lubrication plate on motor indicates otherwise. Refer to motor lubrication plate for specific type and/or grade of lubricant to be used.

Example:

MANUFACTURER	GREASE (NLGI No. 2)
US Electric Motors	Grease No. 83343
Chevron USA Inc.	Grease SRI Grease No. 2
Mobile Oil Corp.	Mobilux 2
Texaco, Inc.	Premium BRB No. 2

REPAIR PARTS:

1. Belts – use only belts of the same type and size furnished.
2. Bearings – replacement adapter bearing units are available from trade channels for installation in pillow block housings when required.
3. Fan Blades – Repair of individual fan blades or propeller assemblies is not recommended. Contact factory with blade size, number of blades, bore size, motor HP, air flow direction, rotation, fan RPM or sheave sizes and any order/tag information that is available for replacement.
4. Misc. Parts – Not available from local trade channels should be returned for repair or replacement. Be sure to obtain return tags or authorization before shipment.
5. Electric Motors – Repair or replacement of motors is normally performed by a repair station authorized by the manufacturer. Contact your representative or the factory for locations nearest to you. **DO NOT** ship motor to the factory without specific authorization.

FAN TROUBLE-SHOOTING CHART

PROBLEM	POSSIBLE CAUSES
Excessive Vibration	<ul style="list-style-type: none"> Propeller, wheel or sheaves loose on shaft Belts loose or too tight Out of balance propeller Excessive buildup of dirt/dust on propeller Bent shaft Weak mounting base for fan Fan mounting bolts loose Loose or worn bearings Bearing or drive misalignment Mismatched belts Structures not crossbraced (wall fans) Curb not flat and level
Excessive Horsepower	<ul style="list-style-type: none"> Static pressure higher than design Wheel or propeller rotating in wrong direction Fan speed higher than design
Too Little Air	<ul style="list-style-type: none"> Restricted fan inlet or outlet Filters are dirty or clogged Wheel or propeller rotating in the wrong direction System is more restrictive (more static pressure) than expected Fan speed lower than design Inlet or Outlet screens clogged
Too Much Air	<ul style="list-style-type: none"> Filters not in place Fan speed higher than design System is less restrictive (less static pressure) than expected
Fan Does Not Operate	<ul style="list-style-type: none"> Wrong voltage Electricity turned off or note wired properly Loose pulleys Blown fuses Overload protector has broken circuit Broken belts
Excessive Noise	<ul style="list-style-type: none"> Propeller, wheel or sheaves loose Bearing or drive misalignment Accumulation of material on propeller Worn or corroded propeller Wheel or propeller out of balance Wheel or propeller hitting housing Bent shaft Defective or bad bearings Bearings need lubrication Loose bearing bolts Loose or worn bearings Mismatched belts Belts too loose or too tight Belts oily or dirty Belts worn Loose fan mounting bolts Rattle of components in high velocity airstream Electrical noise Noise from high velocity air system Vibrating parts not isolated from building Vibrating duct work

Replacement Parts

Model LCE & LCS

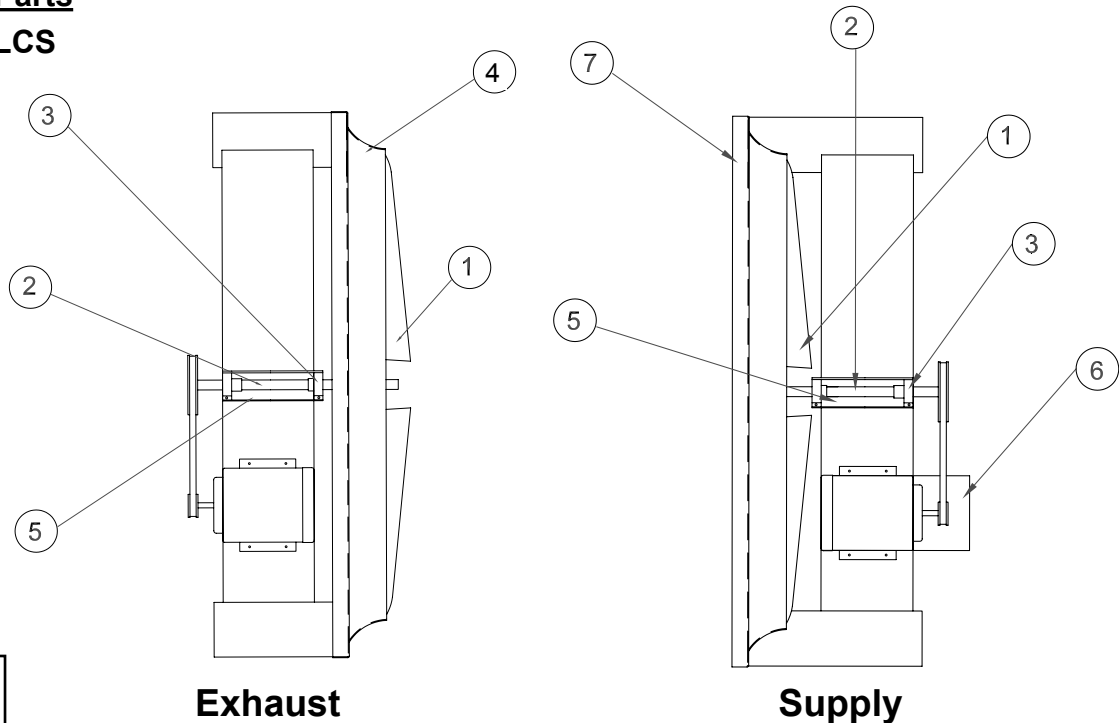

703112 = 3/4"
 703116 = 1"
 703119 = 1 3/16"

Model LCE & LCS	Fan Blade ①	Fan Shaft ②	Bearing (2) ③	Panel - Exhaust ④	Bearing Ext Exhaust ⑤*	Motor Ext*** Supply ⑥
	Part #	Part #	Part #	Part #	Part #	Part #
20	1271.200.112	7073701	703112 (2)	100679	-	-
24	100704	607372	703116 (2)	100698	-	100748
30	100717	607372	703116 (2)	100713	-	100748
36	100732	607372	703116 (2)	100728	1405.6.3	100748
42	100742	LCE: 613505-2 LCS: 607372	703116 (2)	100738	1405.6.3	100748
48	100750	LCE: 613505-2 LCS: 607372	703116 (2)	100746	1405.6.3	100748
54	100752	1423.6.1924	703119 (2)	100757	1405.6.4 *Exhaust or Supply	-
60	700761	1423.6.1924	703119 (2)	100767	1405.6.4 *Exhaust or Supply	-

Model LCE & LCS	Panel - Supply ⑦	Lock Collar **
	Part #	Part #
20	100680	260036
24	100705	260034
30	100718	260034
36	100719	260034
42	100720	260034
48	100721	260034
54	100758	260033
60	100768	260033

* Part # can be used for either exhaust or supply for the Bearing Ext Exhaust (5) as well as the Motor Ext Supply (6).

** Lock Collar cannot be seen in drawing.

*** Use only with TEFC motors.

Replacement Parts

Model L2E & L2S

Sizes 24-36"

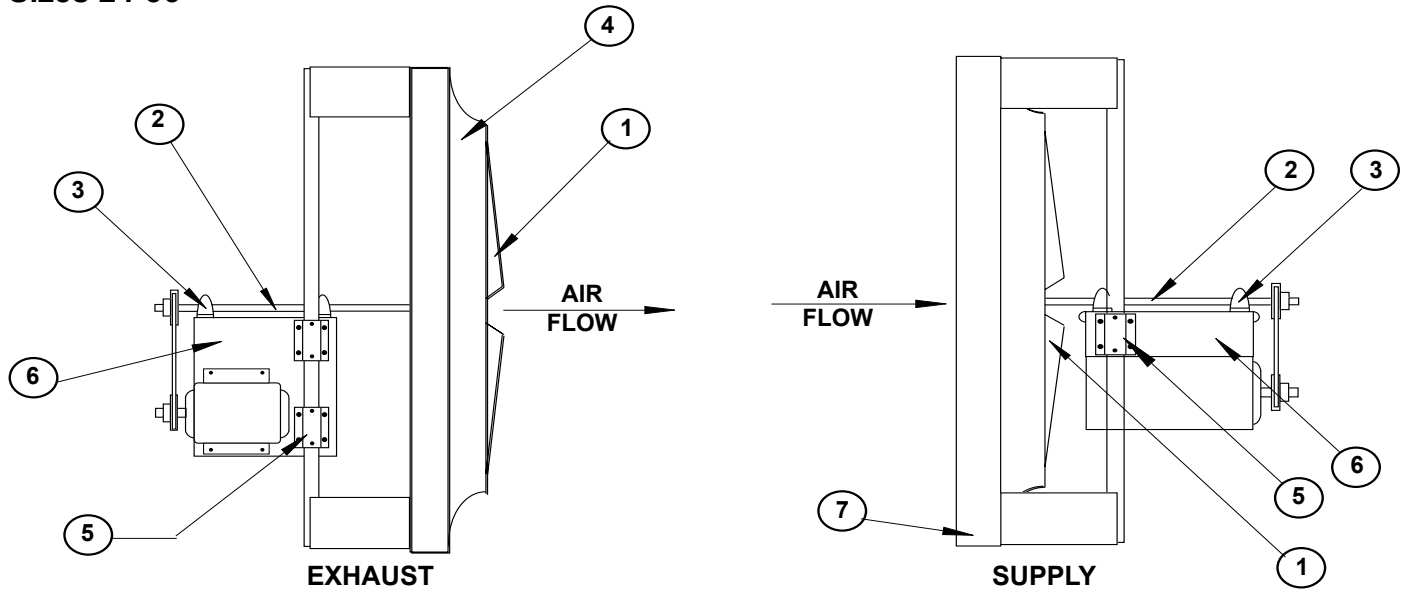

Shaft Size	
3/4"	1423.4.1225
1"	1423.5.1624
1 3/16"	1423.6.1924

Model L2	Fan Blade ①	Shaft ②	Bearing ③	Panel - Exhaust ④
	Part #	Part #	Part #	Part #
24 - 1/4-1 1/2HP	1444.24.2 & 607421	1423.4.1225	703112 (2)	1452.1.24
24 - 2HP	1444.24.2 & 607416	1423.5.1624	703116 (2)	1452.1.24
30 - 1HP	1444.30.16 & 607421	1423.4.1225	703112 (2)	1452.1.30
30 - 1 1/2, 2 & 3HP	1 1/2, 2HP 1444.30.16 & 607416 3HP 1444.30.2 & 607416	1423.5.1624	703116 (2)	1452.1.30
36 - 1/3-1HP	1444.36.1 & 607421	1423.4.1225	703112 (2)	1452.1.36
36 - 1 1/2, 2 & 3HP	1 1/2, 2HP 1444.36.1 & 607416 3HP 1444.36.2 & 607416	1423.5.1624	703116 (2)	1452.1.36
36 - 5HP	1444.36.2 & 607417	1423.6.1924	702119 (2)	1452.1.36

Model L2	Pipe Clamps ⑤	Motor Bracket ⑥	Panel - Supply ⑦
	Part #	Part #	Part #
24 - 1/4-1 1/2HP	1405.11 1" 1405.12 4" (2)	1405.5.8L	1452.2.24
24 - 2HP	1405.11 1" 1405.12 4" (2)	1405.5.8L	1452.2.24
30 - 1HP	1405.12 (3)	1405.5.8L	1452.2.30
30 - 1 1/2, 2 & 3HP	1405.12 (3)	1405.5.8L (3HP) 1405.5.8L & 2501.3M280	1452.2.30
36 - 1/3-1HP	1405.12 (3)	1405.5.8L	1452.2.36
36 - 1 1/2, 2 & 3HP	1405.12 (3)	1405.5.8L (3HP) 1405.5.8L & 2501.3M280	1452.2.36
36 - 5HP	1405.12 (3)	1405.5.8L & 2501.3M280	1452.2.36

Replacement Parts

Model L2E & L2S

Sizes 42-48" 5HP

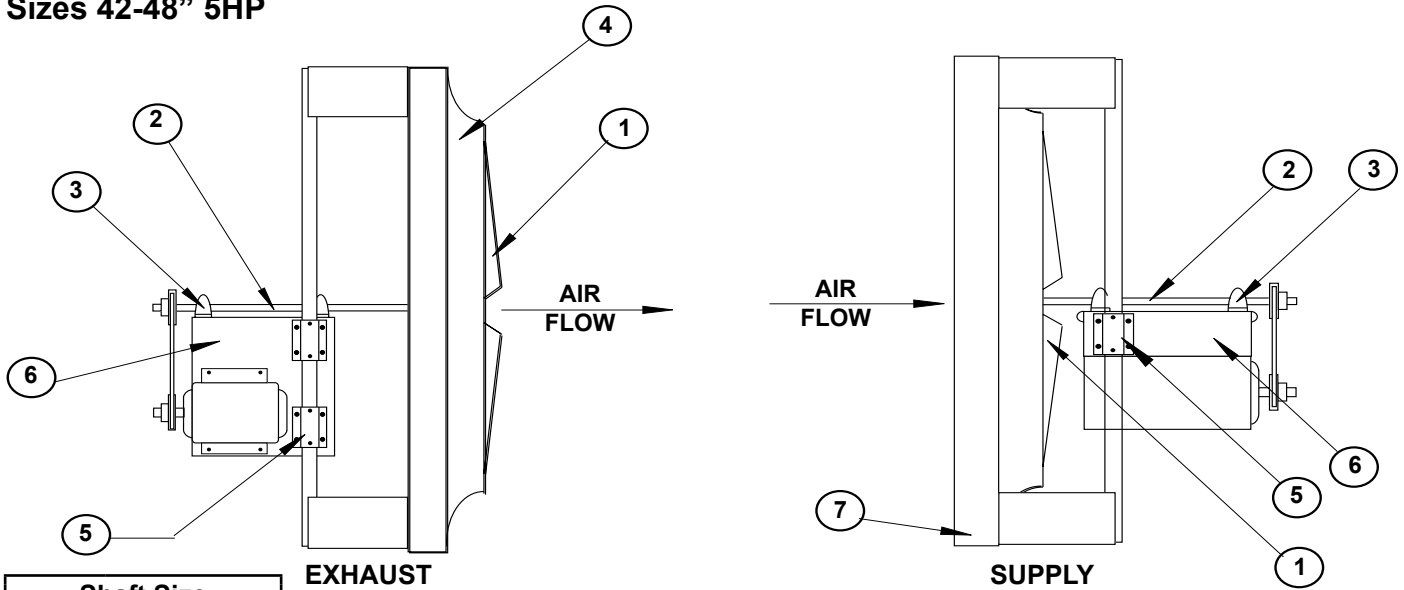

Shaft Size	
3/4"	1423.4.1225
1"	1423.5.1624
1 3/16"	1423.6.1924

Model L2	Fan Blade ①	Shaft ②	Bearing ③	Panel - Exhaust ④
	Part #	Part #	Part #	Part #
42 - 1/3-3/4	1444.42.1 & 607421	1423.4.1225	703112 (2)	1452.1.42
42 - 1 & 3HP	1444.42.1 & 607416 3HP 1444.42.2 & 607416	1423.5.1624	703116 (2)	1452.1.42
42 - 5HP	1444.42.3 & 607417	1423.6.1924	703119 (2)	1452.1.42
48 - 1/2 & 3/4HP	1444.48.1 & 607421	1423.4.1225	703112 (2)	1452.1.48
48 - 1-3HP	1444.48.1 & 607416 3HP 1444.48.2 & 607416	1423.5.1624	703116 (2)	1452.1.48
48 - 5HP	1444.48.3 & 607417	1423.6.1924	703119 (2)	1452.1.48

Model L2	Pipe Clamps ⑤	Motor Bracket ⑥	Panel - Supply ⑦
	Part #	Part #	Part #
42 - 1/3-3/4	1405.12 (3)	1405.5.8L	1452.2.42
42 - 1 & 3HP	1405.12 (3)	1405.5.8L 3HP 1405.5.8L & 2501.3M280	1452.2.42
42 - 5HP	1405.12 (3)	1405.5.8L & 2501.3M280	1452.2.42
48 - 1/2 & 3/4HP	1405.12 (3)	1405.5.8L	1452.2.48
48 - 1-3HP	1405.12 (3)	1405.5.8L 3HP 1405.5.8L & 2501.3M280	1452.2.48
48 - 5HP	1405.12 (3)	1405.1.8L & 2501.3M280	1452.2.48

Replacement Parts

Model L3E & L3S

Sizes 42-7 1/2HP thru 48" 7 1/2 & 10HP & 54"

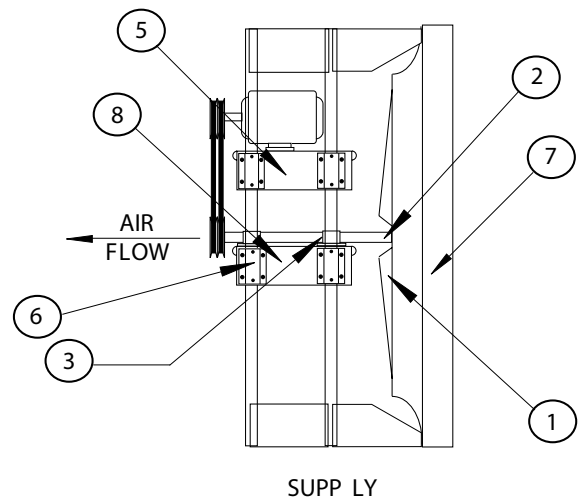
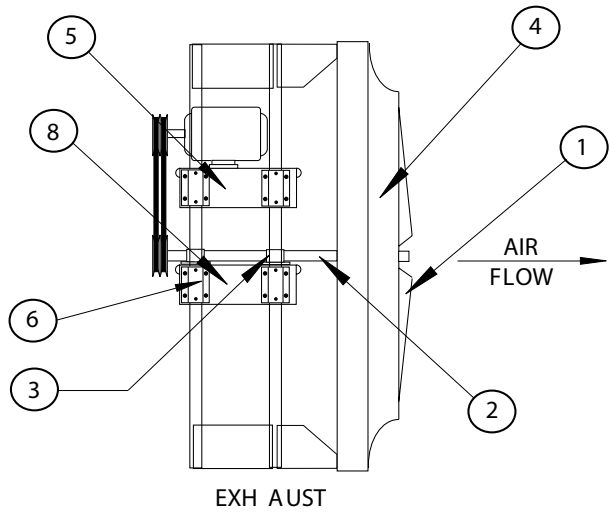

Shaft Size	
1"	1423.5.1624
1 3/16"	1423.6.1924
1 7/16"	1423.7.2328
2 3/16"	1423.8.3530

Model L3	Fan Blade ①	Shaft ②	Bearing ③	Panel - Exhaust ④
	Part #	Part #	Part #	Part #
42 - 7 1/2HP	1444.42.4 & 607451	1423.7.2326	703123 (2)	1455.2.42DP
48 - 7 1/2 & 10HP	1444.48.4 & 607451	1423.7.2326	703123 (2)	1455.2.48DP
54 - 1 & 2HP	1444.54.2 & 607416	1423.5.1624	703116 (2)	1452.1.54
54 - 3 & 5HP	1444.54.3 & 607417	1423.6.1924	703119 (2)	1452.1.54
54 - 7 1/2 & 10HP	1267.540723 & 607451	1423.7.2326	703123 (2)	1455.2.54DP
54 - 15HP	1267.540835 & 607453	1423.8.3530	703135 (2)	1455.2.54DP

Model L3	Pipe Clamps ⑤	Motor Bracket ⑥	Panel - Supply ⑦	Bearing Bracket ⑧
	Part #	Part #	Part #	Part #
42 - 7 1/2HP	1405.12 (8)	1405.5.3H	1455.6.42DP	1405.5.6H
48 - 7 1/2 & 10HP	1405.12 (8)	1405.5.3H	1455.6.48DP	1405.5.6H
54 - 1 & 2HP	1405.12 (3)	1405.5.8L	1452.2.54	-
54 - 3 & 5HP	1405.12 (3)	1405.5.8L & 2501.3M280	1452.2.54	-
54 - 7 1/2 & 10HP	1405.12 (8)	1405.5.3H	1455.6.54DP	1405.5.6H
54 - 15HP	1405.12 (8)	1405.5.3H	1455.6.54DP	1405.5.6H

Replacement Parts

Model L3E & L3S

Sizes 60-72"

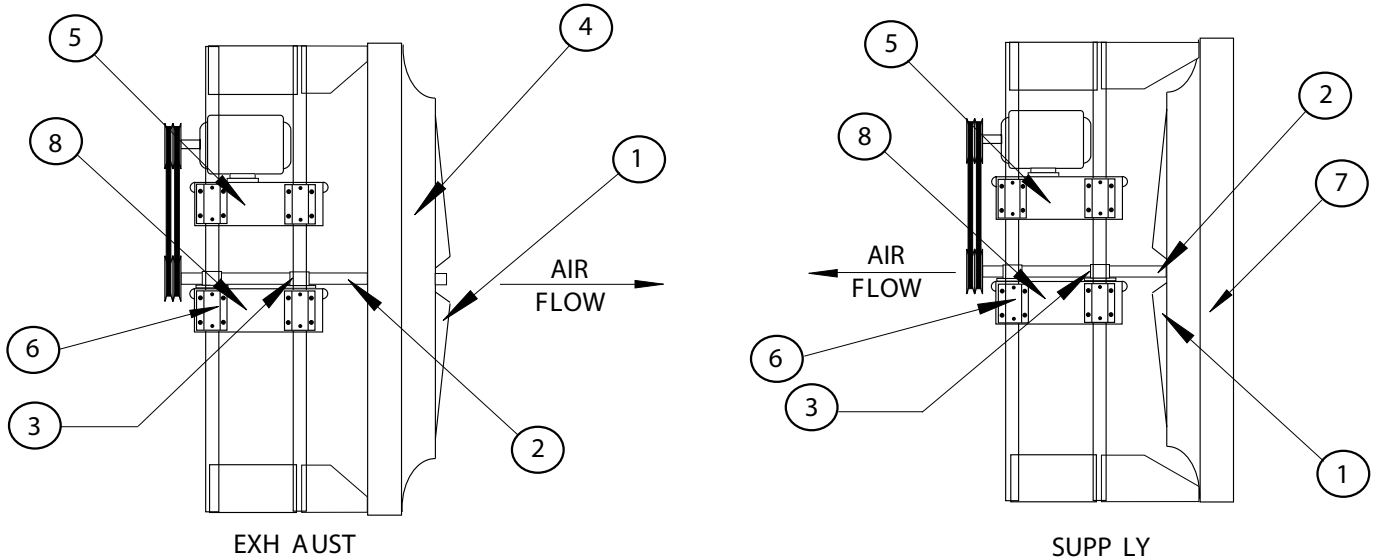

Shaft Size	
1"	1423.5.1624
1 3/16"	1423.6.1924
1 7/16"	1423.7.2328
2 3/16"	1423.8.3530

Models L2 & L3	Fan Blade ①	Shaft ②	Bearing ③	Panel - Exhaust ④
	Part #	Part #	Part #	Part #
60 - 1 & 2HP	1444.60.2 & 607416	1423.5.1624	703116 (2)	1452.1.60
60 - 3 & 5HP	1444.60.3 & 607417	1423.6.1924	703119 (2)	1452.1.60
60 - 7 1/2 & 10HP	1267.600723 & 607451	1423.7.2328	703123 (2)	1455.2.60DP
60 - 15HP	1267.600335 & 607453	1423.8.3530	703135 (2)	1455.2.60DP
72 - 1-5HP	1444.72.3 & 607451 3&5HP 1444.72.4 & 607451	1423.7.2328	703123 (2)	1455.2.72DP
72 - 7 1/2 & 10HP	1268.720423 & 607451	1423.7.2328	703123 (2)	1455.2.72DP
72 - 15HP	1268.720435 & 607453	1423.8.3530	703135 (2)	1455.2.72DP

Models L2 & L3	Motor Bracket ⑤	Pipe Clamps ⑥	Panel - Supply ⑦	Bearing Bracket ⑧
	Part #	Part #	Part #	Part #
60 - 1 & 2HP	1405.5.8L	1405.12 (3)	1452.2.60	-
60 - 3 & 5HP	1405.5.8L & 2501.3M280	1405.12 (3)	1452.2.60	-
60 - 7 1/2 & 10HP	1405.5.3H	1405.12 (8)	1455.6.60DP	1405.5.6H
60 - 15HP	1405.5.3H	1405.12 (8)	1455.6.60DP	1405.5.6H
72 - 1-5HP	1405.5.3H	1405.12 (8)	1455.6.72DP	1405.5.6H
72 - 7 1/2 & 10HP	1405.5.3H	1405.12 (8)	1455.6.72DP	1405.5.6H
72 - 15HP	1405.5.3H	1405.12 (8)	1455.6.72DP	1405.5.6H

WARRANTY:

JencoFan warrants this equipment to be free from defects in material and workmanship for five (5) years from date of shipment. Any units or parts which prove to be defective and are reported during the warranty period will be replaced at our option when returned to our factory, transportation prepaid. Deterioration or wear by heat, abrasive action, chemicals, improper installation or operation or lack of normal maintenance shall not constitute defects, and are not covered by warranty.

The motor is warranted by the motor manufacturer for one year. If the motor becomes defective in the warranty period, it should be taken to the nearest authorized motor service station. If this is not done, the motor manufacturer will not warrant the motor. Call the factory for instructions if authorized service station is not known.

JencoFan will not be responsible for any installation, removal or re-installation costs or any consequential damage resulting in failure to meet conditions of any warranty.

LIMITATION OF WARRANTY AND LIABILITY

This warranty does not apply to any such JencoFan product or parts which have failed as a result of faulty installation or abuse, or incorrect electrical connections or alterations, made by others, or use under abnormal operating conditions or misapplication of the products and parts.

JencoFan will not approve for payment any repairs made outside the factory without prior written consent of its Jacksonville, Florida office.

The foregoing shall constitute our sole and exclusive warranty and our sole and exclusive liability and is in lieu of all other warranties, whether written, oral, implied or statutory. There are no warranties which extend beyond the description of the page hereof. Seller does not warrant that said goods and articles are of merchantable quality or that they are fit for any particular purpose. The liability of seller on any claim of any kind, including negligence, for any loss or damage arising out of or connected with, or resulting from the sale and purchase of the products and parts covered by this proposal, acknowledgement, order or from the performance or breach of any contract pertaining to such sale or purchase, or from the design, manufacture, sale, delivery, resale, installation, technical direction of installation, inspection, repair, operation or use of any products or parts covered by this proposal, acknowledgement, order or furnished by seller shall, in no case exceed the price allocable to the products or parts thereof which give rise to the claim and shall terminate one (1) year after the shipment of said products and parts.

In no event, whether as a result of breach of contract, or warranty or alleged negligence, defects, incorrect advice or other causes, shall seller be liable for special or consequential damages, including, but not limited to, loss of profits or revenue, loss of use of the equipment or any associated equipment, cost of capital, cost of substitute equipment, facilities or services, down time costs, or claims of customers of the purchaser for such damages. JencoFan neither assumes nor authorizes any persons to assume for it any other liability in connection with the sale of its fan products and parts. Some states do not allow the exclusion or limitation of incidental or consequential damages, so all of the above limitations or exclusions may not apply to you.

SAFETY ACCESSORIES WARNING:

The responsibility for providing safety accessories for equipment supplied by JencoFan is that of the installer and user of this equipment. JencoFan sells its equipment with and without safety accessories, and accordingly it can supply such safety accessories upon receipt of order.

The user, in making its determination as to the appropriate safety accessories to be installed and any warning notices, should consider (1) the location of the installation, (2) the accessibility of employees and other persons to this equipment, (3) any adjacent equipment, (4) applicable building codes, and (5) requirements of the Federal Occupational Safety and Health Act.

Users and installers of this equipment should read "RECOMMENDED SAFETY PRACTICES FOR AIR MOVING DEVICES" which is published by Air Movement and Control Association, 30 West University Drive, Arlington Heights, Illinois 60004.